



## MIXMASTER VII™

Range of Mixer, Agitator, Reactor & Dryer  
Seals for Dry Running Applications



- AVAILABLE IN A COMPLETE RANGE OF INCH AND METRIC SIZES
- PATENT PENDING DRY RUNNING DESIGN FEATURES
- AVAILABLE TO SUIT DIN 128 138 PARTS 1 & 2
- NON-METALLIC INVENTORIED DESIGNS WITH GLASS ENAMELLED FLANGES TO DIN 28 137 PART 2



## Mixmaster Range of Cartridge Seals for Mixers

This brochure covers the range of AESSEAL® Mixmaster mechanical seals designed for mixers, agitators, reactors and dryers operating in dry running environments.

Mixing applications vary from simple blending or solid dissolution to the more exacting standards of solids suspension, gas dispersion or containing/promoting chemical reactions.

Various applications, such as horizontal drying, preclude the use of a liquid barrier fluid due to process contamination possibilities. In such applications, the attraction of an inert non-contaminating barrier fluid is clearly advantageous.

By far, the largest demand for gas barrier systems is in the FDA and pharmaceutical industries. As such, AESSEAL® has developed a range of dry running mechanical seals and seal support systems for such applications and industries.

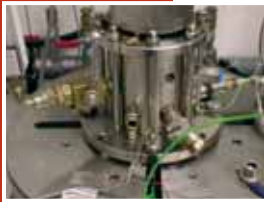

### Development Background

The AESSEAL® Mixmaster VII™ range has been developed following an extensive performance evaluation test program over an 18 month period.

The dry running seal technology, specifically the seal face geometry, damper and close coupled devices, have been created using the latest Computer Aided Design, Manufacture and simulation software.

The product range has been verified and performance optimized using sound level metering, spectrum analysis, gas flow and temperature instrumentation and continuous data logging software.



The result is a range of inventoried, patent pending mechanical seals, which extend the boundaries of conventional products, allowing wider application of the technology and benefits.

### The seal range is offered with the following design features:

- Designed for mixers, agitators, reactors and dryers.
- Specifically for dry nitrogen applications to 10 barg (150 psig).
- Double hydraulically balanced seal faces
- Available with non-metallic wetted components
- Cartridge seal with integral load carrying bearing to DIN 28 138 parts 1 and 2
- No shaft fretting and available to suit any shaft (within the size range)

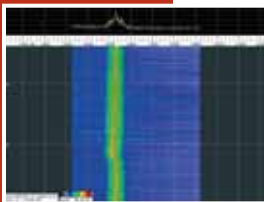

## Specifications Mixmaster VII™

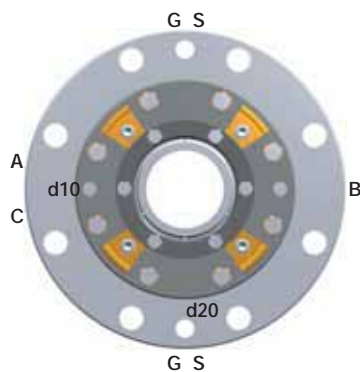

- A = Barrier IN
- B = Barrier OUT
- C = Leakage to Atmosphere
- G = Grease Port
- S = Stationary Cooling Port
- d10 = Lifting Threads
- d20 = Jacking Threads

MIXMASTER VII™ Load Carrying Capabilities			
ØD3	DIN 28 159 Max Loads		
40mm (1.500")	1,562 N	351 lbs	
50mm (2.000")	3,468 N	779 lbs	
60mm (2.375")	6,640 N	1,492 lbs	
80mm (3.125")	17,289 N	3,886 lbs	
100mm (4.000")	34,820 N	7,827 lbs	
125mm (5.000")	44,188 N	9,933 lbs	
140mm (5.500")	38,147 N	8,575 lbs	
160mm (6.250")	60,185 N	13,530 lbs	

The Mixmaster VII™ range of mixer seals conform to the following relevant DIN Specifications:

- DIN 28 138 part 1 - Stainless Mixer Seal
- DIN 28 138 part 2 - Glass Lined
- DIN 28 138 part 3 - Screwed Connection Designation & Position
- DIN 28 137 part 2 - Glass Lined Mounting Flanges
- DIN 28 141 - Stainless Steel Mounting Flanges
- DIN 28 154 & 159 - Shaft Dimensions

# AESSEAL® - Better by Design



There are two main strategies in the supply of dry running mechanical seals:

- The use of non-contacting seal face technology
- The use of contacting seal face technology

There is a growing awareness amongst plant engineers that non-contacting seal face designs employing hydrodynamic gas lift technology, are particularly prone to premature seal failure. The failure modes of such designs are well documented and include:

- inconsistent gas supply,
- unfiltered, dirty gas leading to clogging of the gas lift grooves, and
- equipment/seal misalignment or installation errors.

When the hydrodynamic non-contacting design fails to create enough lift to separate the counter opposed seal faces, massive heat generation will result. The problems encountered in the field with non-contacting seal face technology have seen many engineers consider the wider use of contacting seal face technology.

Contacting seal face technology means the two counter opposed seal faces run dynamically against one another. In marginal lubrication and/or dry gas applications this dynamic contact can lead to environmentally unacceptable noise levels, increased seal face wear and high heat generation.

The AESSEAL® dry running seal range deals with each of these through the application of innovative design principles, pioneered after many thousands of hours of testing and evaluation. These features are described below;

## Noise Generation - Patent Pending Solution

Noise is energy generated as the seal rotary member resonates at a specific frequency. Following extensive tests it was noted that seal face temperatures rose during periods of high noise.

The AESSEAL® patent pending solution to resolve this issue is to provide torsional damping to the rotary seal members. This solution reduces the resulting noise and corresponding seal face temperature excursions.

**Seal Face Wear** - Less than any published data on a comparable product  
Seal face wear occurs as a result of a number of variables including seal face hydrostatic balance, seal face width, spring closing force, amount of seal face leakage and the grade of seal face materials employed.

Again, after many thousands of hours testing, AESSEAL® have standardized on what it considers the optimum set of variables for agitator and mixing applications. This is somewhat verified when viewing the gas leakage graph benchmarked against published competitor data and the seal life graph shown.

## Heat Generation

All contacting seal faces will generate heat. For any given seal face design and geometry, heat generated is a function of seal face rotating velocity and closing force pressure.

The heat created by the seal faces is dissipated through the associated parts in the seal design. Seal face elastomers can act to insulate the seal faces, preventing effective heat dissipation into heat sink areas such as the gland member.

AESSEAL® have developed “close-coupled” technology which address heat build up in the stationary seal. This modular design employs the same components as the cooled seat design, therefore allowing the optimum product selection to be made for the application.

A further design option of the Mixmaster VII™ range is the use of the AESSEAL® CLIP™ seal on the outboard side of the seal.

The graph below illustrates the respective performance of each heat dissipating design.

The innovative solutions and techniques employed by AESSEAL® have led to an extension of the operating performance of contacting dry gas seals in a number of design configurations as shown overleaf.

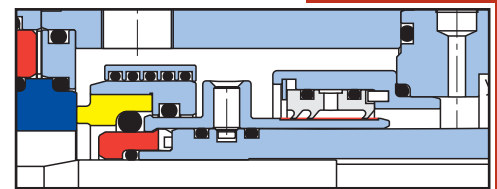
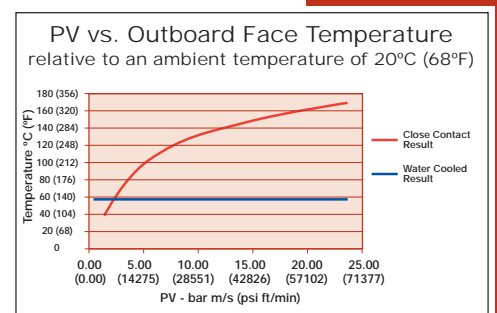
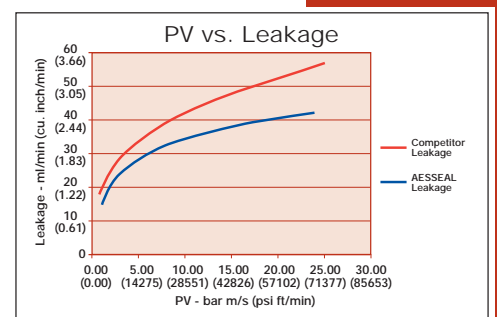
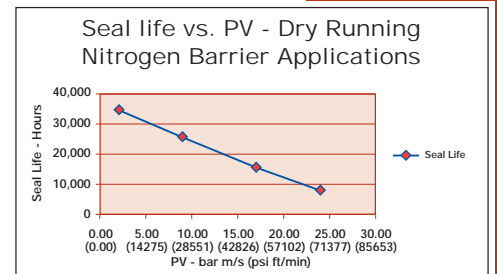

Figure above shows inboard damper and outboard CLIP™ seal configuration





# Mixmaster VII™ & Mixmaster VII-D™

Mixmaster VII-D™  
Double seal with Bearing &  
Outboard Cooled Stationary.

Mixmaster VII™  
Double seal with Bearing &  
Outboard Close-coupled Stationary.

Mixmaster VII™  
Double seal without Bearing & with  
Outboard Close-coupled Stationary.

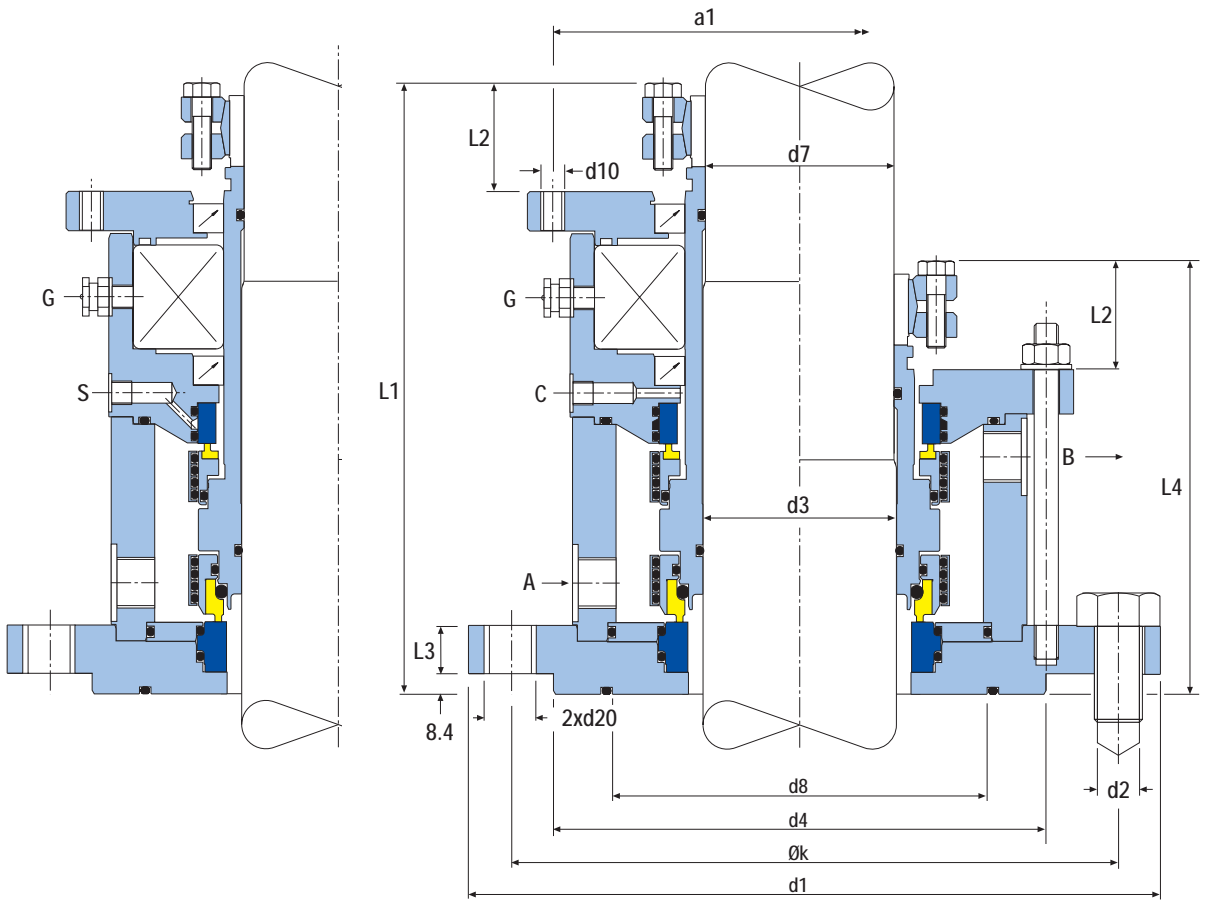

Mixmaster VII™ Stainless Steel Size Chart (mm)

d3	d7	d1	nxd2	d4	d8	Øk	L1	L2	d10	d20	A,B	C	S	L3	L4	a1
40	38	175	4x18	110	92	145	208	32	M12	M16	G3/8	G1/8	G1/8	19	149	132
50	48	240	8x18	176	136	210	213	32	M12	M16	G3/8	G1/8	G1/8	17	152	155
60	58	240	8x18	176	140	210	217	32	M12	M16	G3/8	G1/8	G1/8	17	155	164
80	78	275	8x22	204	155	240	253	45	M16	M20	G1/2	G1/8	G1/4	20	179	204
100	98	305	8x22	234	187	270	256	45	M16	M20	G1/2	G1/8	G1/4	20	179	215
125	120	330	8x22	260	213	295	293	46	M20	M20	G1/2	G1/8	G1/4	20	200	275
140	135	395	12x22	313	251	350	306	46	M20	M20	G1/2	G1/8	G1/4	20	208	285
160	150	395	12x22	313	251	350	306	46	M20	M20	G1/2	G1/8	G1/4	25	208	292

Dimensional information on larger sizes is available on request.

## Mixmaster VII™ Imperial Size Information

The modular design of the Mixmaster VII™ enables the product to be offered to suit ANY shaft size. The table below shows the inch size range. Larger sizes up to 300mm (12.000") are designed to order.

Mixmaster VII™ Stainless Steel Size Chart (inches)

d3	d7	d1	nxd2	d4	d8	Øk	L1	L2	d10	d20	A,B	C	S	L3	L4	a1
1.125" - 1.500"	-	6.890"	4 x 0.700"	4.33"	3.62"	5.71"	8.19"	1.26"	M12	M16	G3/8	G1/8	G1/8	0.59"	5.87"	5.20"
1.625" - 1.875"	-	9.450"	4 x 0.700"	6.93"	5.35"	8.26"	8.38"	1.26"	M12	M16	G3/8	G1/8	G1/8	0.67"	5.98"	6.10"
2.000" - 2.375"	-	9.450"	4 x 0.700"	6.93"	5.51"	8.26"	8.54"	1.26"	M12	M16	G3/8	G1/8	G1/8	0.67"	6.10"	6.46"
2.500" - 3.125"	-	10.830"	8 x 0.875"	8.03"	6.10"	9.45"	9.96"	1.77"	M16	M20	G1/2	G1/8	G1/4	0.79"	7.05"	8.03"
3.250" - 4.000"	-	12.000"	8 x 0.875"	9.21"	7.36"	10.63"	10.10"	1.77"	M16	M20	G1/2	G1/8	G1/4	0.79"	7.05"	8.46"
4.125" - 5.000"	-	13.000"	8 x 0.875"	10.24"	8.38"	11.61"	11.54"	1.81"	M20	M20	G1/2	G1/8	G1/4	0.79"	7.87"	10.83"
5.125" - 5.500"	-	15.550"	12 x 0.875"	12.32"	9.88"	13.78"	12.05"	1.81"	M20	M20	G1/2	G1/8	G1/4	0.79"	8.19"	11.22"
5.625" - 6.250"	-	15.550"	12 x 0.875"	12.32"	9.88"	13.78"	12.05"	1.81"	M20	M20	G1/2	G1/8	G1/4	0.98"	8.19"	11.50"

Dimensional information on larger sizes is available on request.



# Mixmaster VII™ & VII-D™ Exotic & Non-metallic Designs

Non-metallic Mixmaster VII™  
Double seal with Bearing & Outboard  
Close-coupled Stationary.

Non-metallic Mixmaster VII™  
Double seal without Bearing & with  
Outboard Close-coupled Stationary.

Exotic Mixmaster VII-D™  
Double seal with Bearing &  
Outboard Cooled Stationary.

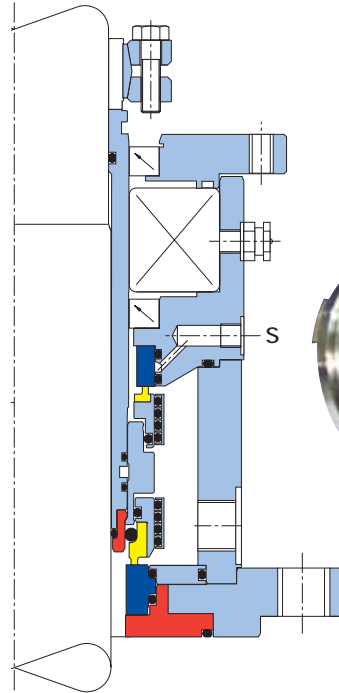
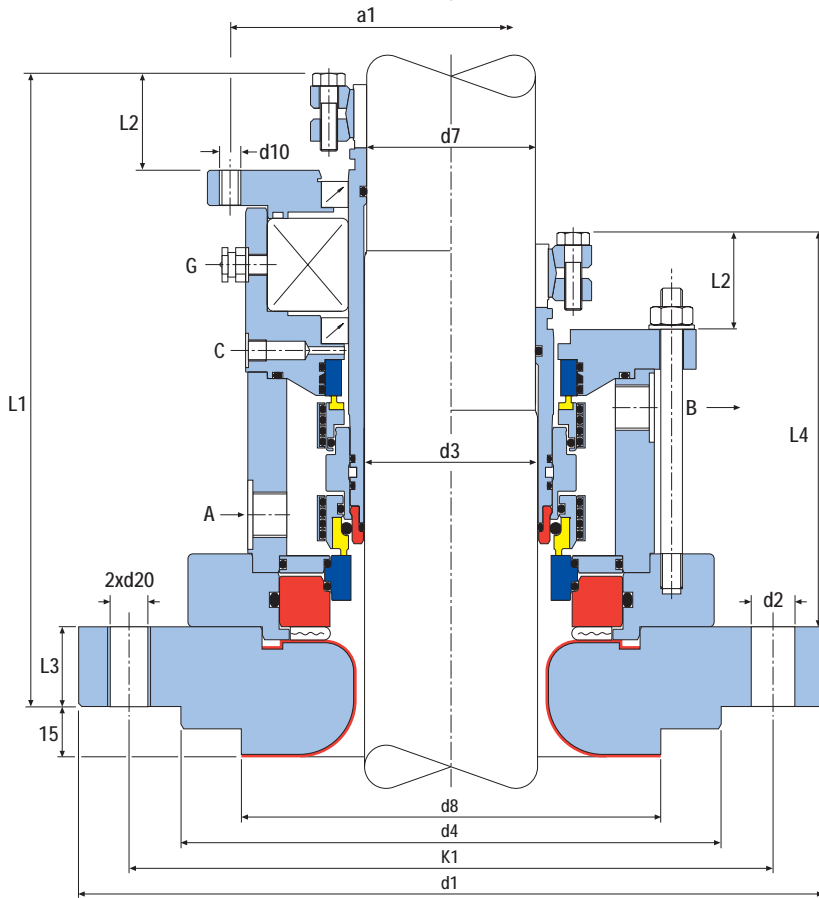

## E700-E901 Flange Nominal Diameters

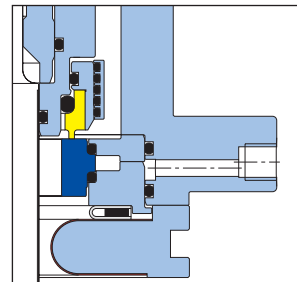
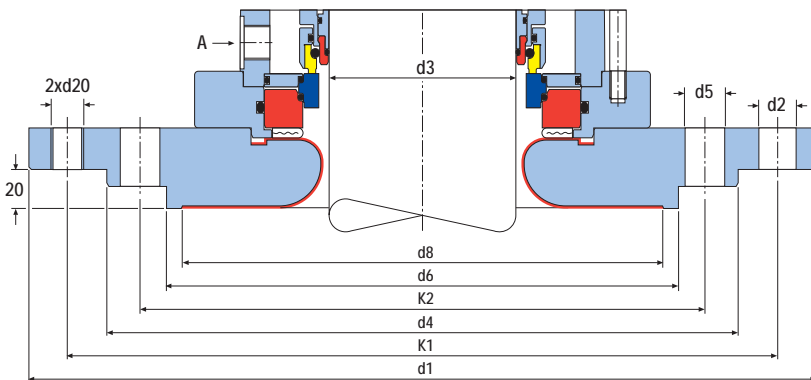

Exotic Mixmaster VII-DD™  
Double seal with bearing &  
cooled stationary seats.

## Mixmaster VII-BG™ Size Chart (mm)

d3	d7	d1	nx d2	d4	nx d5	d6	d8	d10	d20	a1	L1	K1	K2	L3	L2	L4	A,B	C	S	NFD
40	38	175	4x18	110	-	-	102	M12	M16	132.5	225	145	-	20	33	146	G3/8	G1/8	G1/8	E125
50	48	240	8x18	176	-	-	138	M12	M16	155	236	210	-	25	33	152	G3/8	G1/8	G1/8	E200
60	58	275	8x22	204	-	-	188	M12	M16	164	240	240	-	25	34	155	G3/8	G1/8	G1/8	E250
80	78	305	8x22	234	-	-	212	M16	M20	204	280	270	-	30	45	181	G1/2	G1/8	G1/4	E300
100	98	395	12x22	313	-	-	268	M16	M20	215	283	350	-	30	45	181	G1/2	G1/8	G1/4	E500
125	120	505	4x22	422	12x22	320	306	M20	M20	275	319	460	350	30	46	202	G1/2	G1/8	G1/4	E700
140	135	505	4x22	422	12x22	320	306	M20	M20	285	332	460	350	30	52	210	G1/2	G1/8	G1/4	E700
160	150	505	4x22	422	12x22	320	306	M20	M20	292	328	460	350	30	52	210	G1/2	G1/8	G1/4	E900
160*	150	565	4x26	474	12x22	370	356	M20	M20	292	328	515	400	30	52	210	G1/2	G1/8	G1/4	E901

\* Nominal size 161

Dimensional information on larger sizes is available on request.



## Other AESSEAL® Dry Running Seal Designs

Since the late 1990's, AESSEAL® have developed and installed a full range of dry running contacting seal designs. These range from the simple clipped external seals employed on top entry mixers to the more exacting non-metallic axial movement dual seals with twin bearings employed on horizontal drying equipment. Examples of such products are shown below.

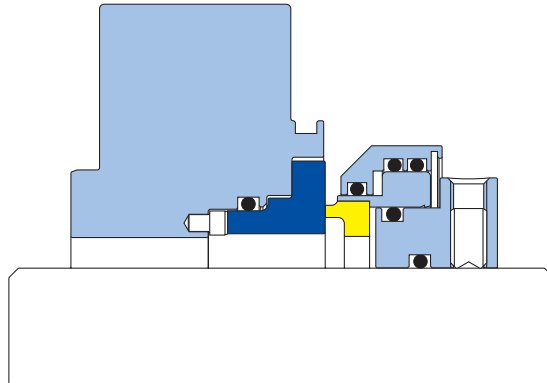

**Dry running NCM™ design**  
AESSEAL® entry-level dry running technology starts with the external single component clipped seal, with rotary damper and hybrid seal face technology.

This design is applicable to seal vapour on low-duty top entry mixing vessels.

### Back to Back dry running design

The next level in the dry running component seal range is the back to back design. This is offered with a double hydraulically balanced inboard rotary, non-fretting hydraulically balanced outboard rotary and damper, with hybrid dry running seal face technology.

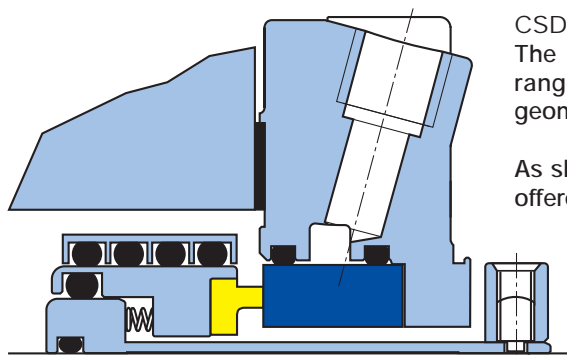
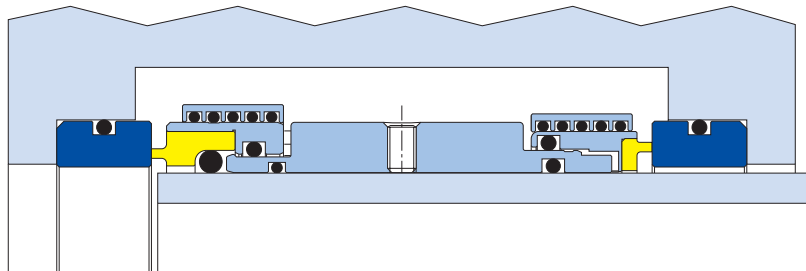

**CSDR™ - Close Coupled seat single cartridge seal**  
The CSDR™ is the entry level single cartridge seal range, offered with rotary damper and hybrid face geometry and a close-coupled stationary seal face.

As shown to the left, the CSDR-C™ is the sister design offered as standard with a cooled stationary seal face.

The AESSEAL® dry running mechanical seal product range is diverse and far reaching, offering the full compliment of sealing solutions for practically all mixing, agitating, reacting and drying applications.

The Mixmaster VII™ is typically inventoried in DIN 28 138 shaft designs and flange configurations. Seals for popular equipment vessels and models are also inventoried. Other design variants shown are usually configured to suit customer requirements and are typically on a longer lead-time.



### Dual Mixmaster with dampers

Special Mixmaster VII's and VII-D's, with stainless, exotic or non-metallic wetted parts and dual-bearing arrangements can be configured to accommodate large amounts of axial shaft movement. This is achieved using sliding keyway or axial compensating rolled metal bellows technology. The design can also be supplied with various customized features including an inboard debris-well as shown.

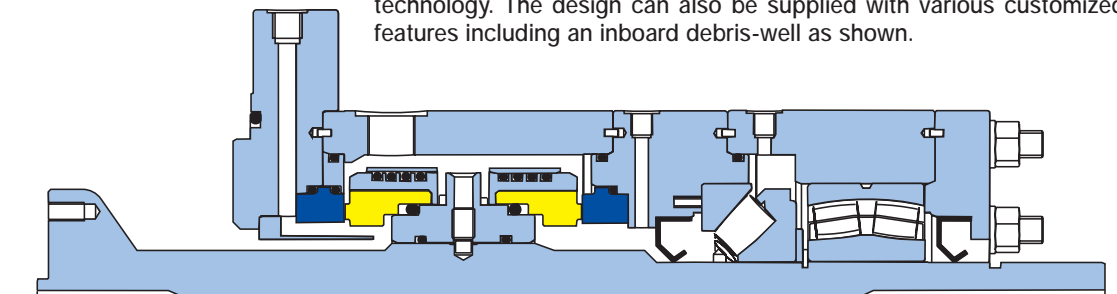

### Glass lined Mixmaster with CLIP™ seal on the outboard

All Mixmaster VII's have the modular option of an outboard cartridge lipseal design using AESSEAL® CLIP™ seal technology. A popular choice in the Mixmaster configuration, due to the integral bearing support, the CLIP™ seal runs on an extended and hardened inner barrel and may be offered in a FDA compliant material.

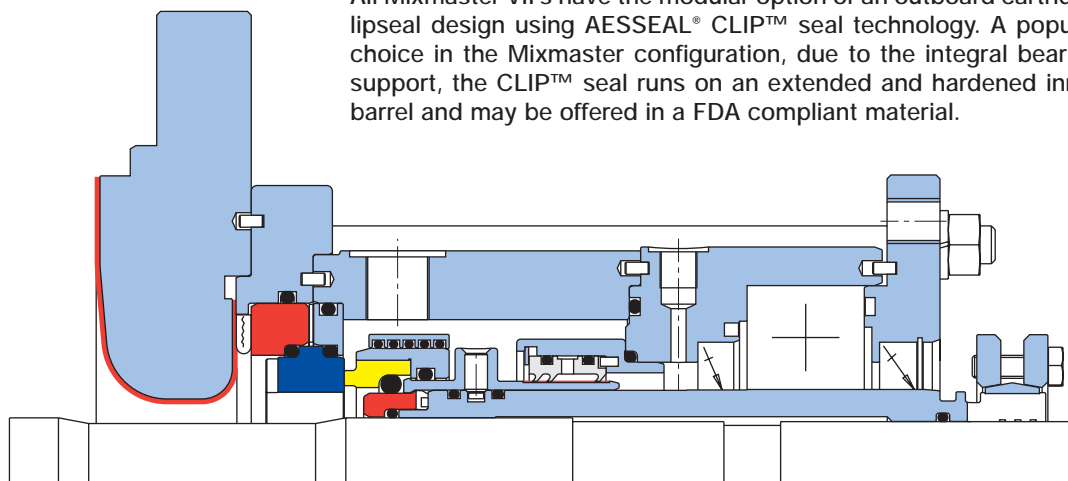

### Mixmaster with inboard and outboard cooled seat

In particularly arduous applications where the process vapour offers limited or no inboard seal face lubrication properties, the Mixmaster VII-DD™ is offered with cooled stationary seal faces both inboard and outboard as shown below.

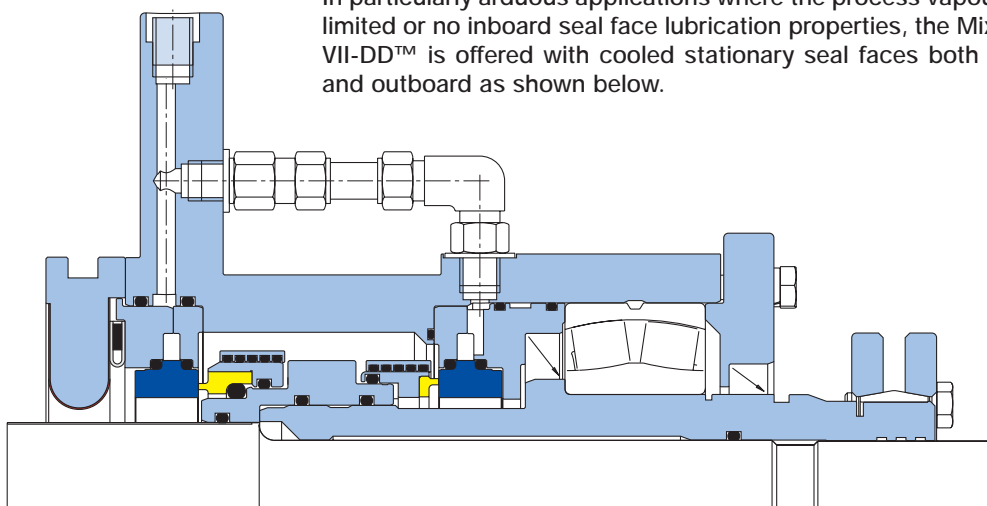

# AESSEAL® - GAS16-P1™ Support System

As with all AESSEAL® mechanical seal product ranges, the AESSEAL® dry running seal range is supported with a full compliment of seal support systems for humidified or dry nitrogen duties. The patent pending GAS16-P1™ Support System is offered with many design features including:

- Inlet Pressure 20 barg (300 psig)
- Working Pressure Max 16 barg (240 psig)
- Polyester Instrument Cabinet
- Isolating Valve
- Drain Valve
- Non-return Valve
- Pressure Gauge and Regulator
- Coalescing Filter
- High and Low Flow Meters
- Push-in Pipework
- Optional Instrumentation



Above: All instruments are inside the cabinet

Item	Description
1	Isolating Valve
2	Coalescing Filter
3	Pressure Regulator
4	Pressure Gauge
5	Pressure Switch
6	Flow Meter - Low
7	Flow Meter - High
8	Non-return Valve
9	Drain Valve
10	Cabinet
11	Flow Switch (optional)

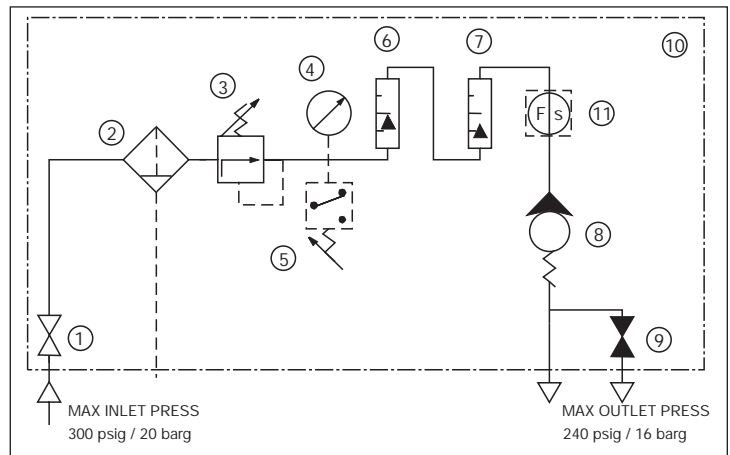

As the system design is modular, the basic unit can be adapted to suit most on-site specifications and requirements. Possible adaptations include a pressure switch and high/low level indicators.

THIS DOCUMENT IS DESIGNED TO PROVIDE DIMENSIONAL INFORMATION AND AN INDICATION OF AVAILABILITY. FOR FURTHER INFORMATION AND SAFE OPERATING LIMITS CONTACT OUR TECHNICAL SPECIALISTS AT THE LOCATIONS BELOW.



INVESTOR IN PEOPLE



USE DOUBLE MECHANICAL SEALS WITH HAZARDOUS PRODUCTS. ALWAYS TAKE SAFETY PRECAUTIONS:

- GUARD YOUR EQUIPMENT
- WEAR PROTECTIVE CLOTHING



WARNING

#### UK Sales & Technical advice:

AESSEAL plc  
Mill Close  
Templeborough  
Rotherham  
S60 1BZ  
United Kingdom

Telephone: +44 (0) 1709 369966  
Fax: +44 (0) 1709 720788  
E-mail: [seals@aesseal.com](mailto:seals@aesseal.com)  
Internet: <http://www.aesseal.com>

Distributed by:

Our Purpose: *'To give our customers such exceptional service that they need never consider alternative sources of supply.'*

#### USA Sales & Technical advice:

AESSEAL Inc.  
10231 Cogdill Road  
Suite 105  
Knoxville, TN 37932  
USA

Telephone: +1 865 531 0192  
Fax: +1 865 531 0571  
E-mail: [usa@aesseal.com](mailto:usa@aesseal.com)

#### Systems Sales & Technical advice:

AESSEAL (MCK) Ltd.  
139A Hillsborough Old Road  
Lisburn  
N.Ireland  
BT27 5QE

Telephone: +44 (0) 28 9266 9966  
Fax: +44 (0) 28 9266 9977  
Tel/Fax Hotline: +44 (0) 28 9266 9988  
E-mail: [MCK@aesseal.com](mailto:MCK@aesseal.com)